



Amherst Belt Lines Modular Railway System Amherst Railway Society Amherst, MA



MODULE DRAWINGS

2016 Edition

Contents

Overview	2
4' Module based on 'Off-the-Shelf' dimensional lumber (simplified construction)	3
6' Module based on 'Off-the-Shelf' dimensional lumber (simplified construction)	4
Simple legs 'Off-the-Shelf' dimensional lumber (simplified construction)	5
4' Module based on 'Ripped-to-Size' lumber (dado joints)	6
6' Module based on 'Ripped-to-Size' lumber (dado joints)	7
Standard legs 'Ripped-to-Size' lumber (simplified construction)	8
Corner Module	9

Overview

The enclosed drawings are meant to be used as a reference guide for someone that has either chosen to build their own module or an example of what their completed module kit will assemble into. These are not precise blueprints, but a dimensional drawing that represents two of the infinite number of options for module construction. One could follow these as show, or use this a basis for your own design. In the end, as long as the final product is of sound construction and adheres to the module specifications (separate document) it will be accepted for use in our show layouts.

There are two basic designs presented here, 'Off the Shelf' and 'Ripped-to-Size'. Both have certain advantages, but in the end it is suggested that you follow which ever you are more comfortable with.

'Off the Shelf' Design: These are drawings based on using dimensional lumber readily available at most home improvement stores. It would even be feasible to that you could cut and assemble this without the use of power tools. The drawing and material dimensions are based on simple butt-joint construction. This is the simplest form of construction which most DIY'rs can readily tackle.

'Ripped-to-Size' Design: These are drawings based on using cabinet grade plywood (minimum 7-ply) and ripping the sheet into the appropriate dimensions on a table-saw. Additionally this design incorporates the use of dado-joints which result in a stronger joint. Dado joints can be created with a dado-blade on a saw, or the use of a router.

If you have any questions, comments or concerns about these specifications or the module building process, please reach out to the modular coordinators sooner rather than later via amherstbeltlines@amherstrail.org.

OF NOTE:

- *The Corner Module drawing is a draft. Additional details will be added but this may be used as a reference to build your own. The updated version will have additional details construction styles, measurements, materials and legs.*

"Off the Shelf" Material Construction

Top View

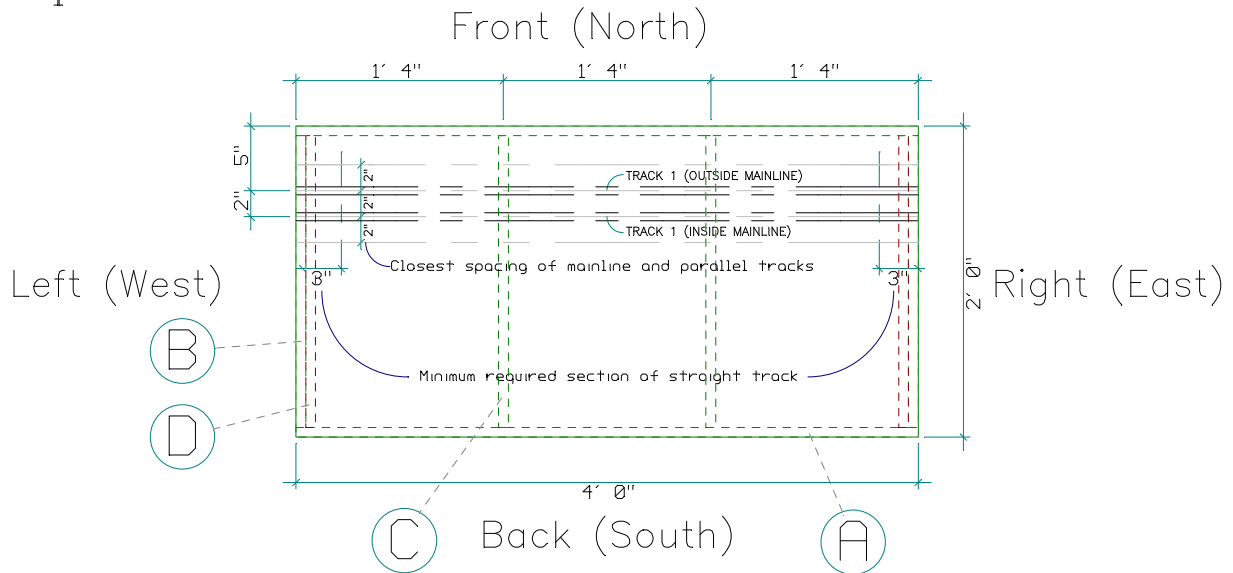

Side View

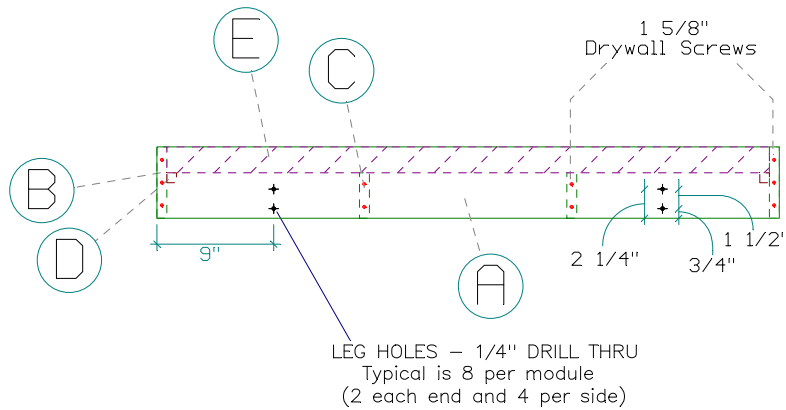

Item	Description	Dimensions	Qty
A	1 x 6 Pine (nominal: 3/4" x 5 1/2")	3/4" x 5 1/2" x 48"	2
B	1 x 6 Pine (nominal: 3/4" x 5 1/2")	3/4" x 5 1/2" x 22 1/2"	2
C	1 x 4 Pine (nominal: 3/4" x 3 1/2")	3/4" x 3 1/2" x 22 1/2"	2
D	3/4 x 1/2 Pine Stock Molding	3/4" x 1/2" x 22"	2
E	2" Extruded Foam Isulation	2" x 22 1/2" x 46 1/2"	1

Not to Scale

"Off the Shelf" Material Construction

Top View

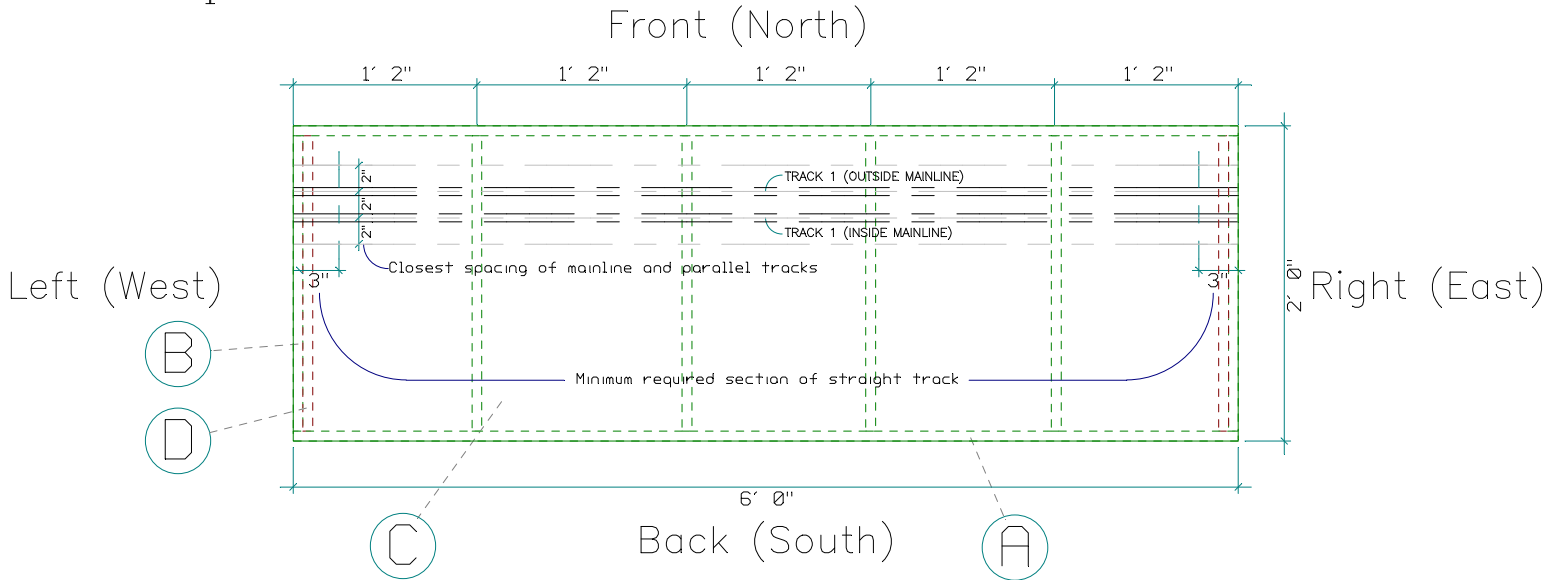

Side View

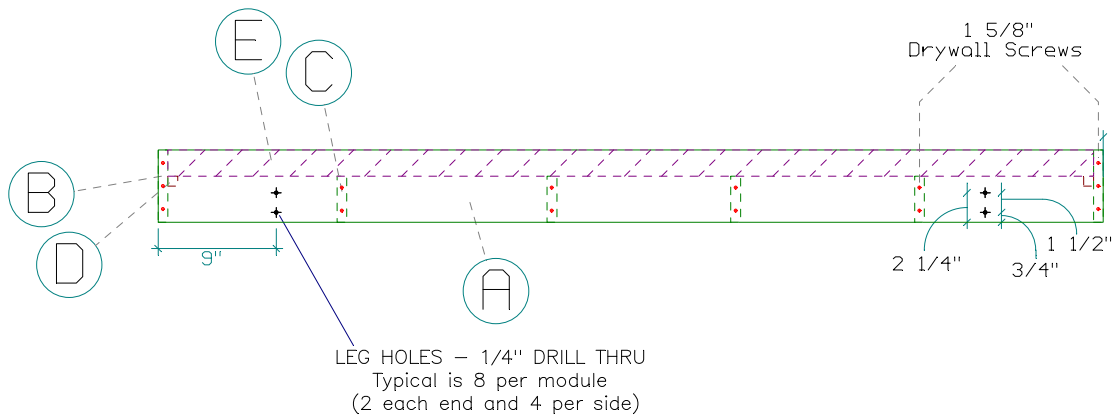

Item	Description	Dimensions	Qty
A	1 x 6 Pine (nominal: 3/4" x 5 1/2")	3/4" x 5 1/2" x 72"	2
B	1 x 6 Pine (nominal: 3/4" x 5 1/2")	3/4" x 5 1/2" x 22 1/2"	2
C	1 x 4 Pine (nominal: 3/4" x 3 1/2")	3/4" x 3 1/2" x 22 1/2"	2
D	3/4 x 1/2 Pine Stock Molding	3/4" x 1/2" x 22"	2
E	2" Extruded Foam Isulation	2" x 22 1/2" x 70 1/2"	1

Not to Scale

Top View

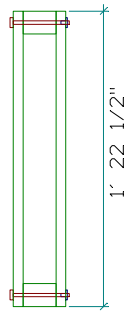

Side View

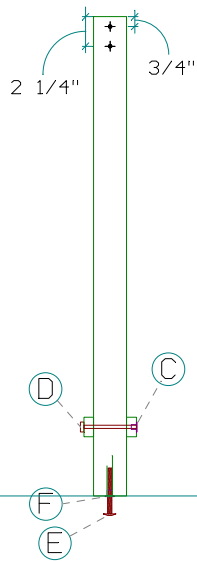

End View

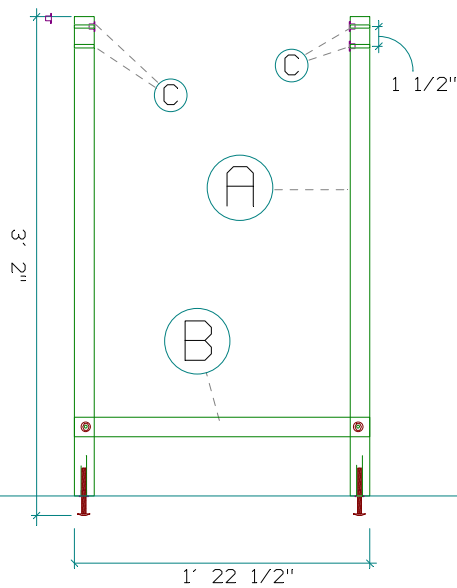

A	2" X 3" Pine	[1 1/2" x 2 1/2" x 36 1/2"]	2
B	1" x 2" Pine	[3/4" x 1 1/2" x 22 1/2"]	2
C	1/4 - 20 T-Nut		6
D	1/4" - 20 Hex Bolt	[4"]	2
E	5/16 - 18 Carriage Bolt	[4"]	2
F	5/16" - 18 T-Nut		1

Not to Scale

Cabinet Grade Plywood with Dado Joints

Top View

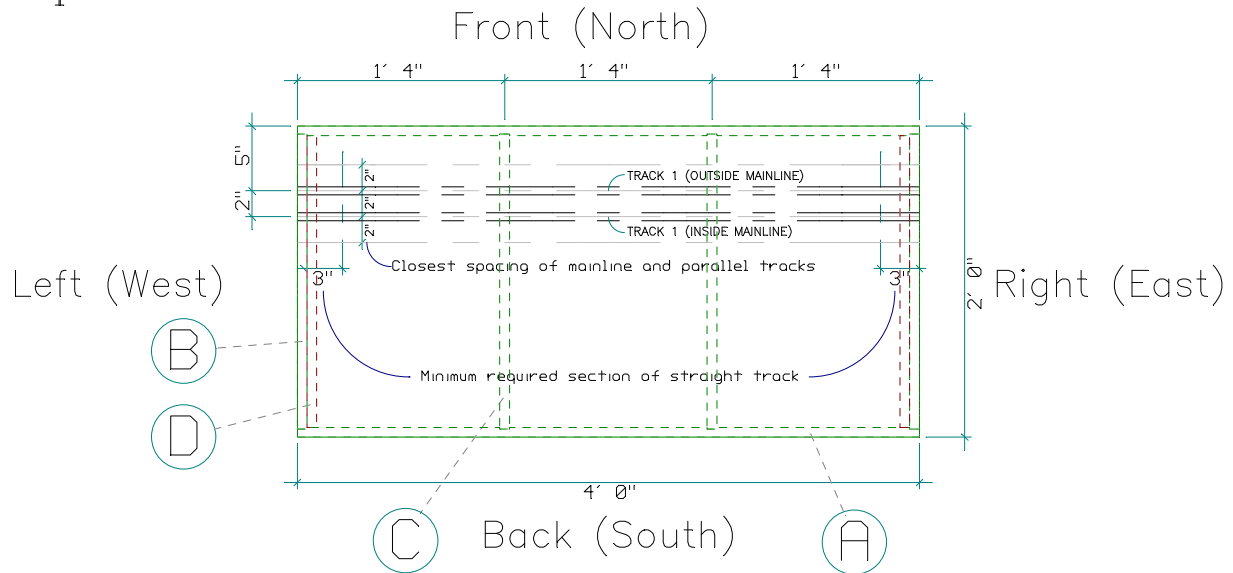

Side View

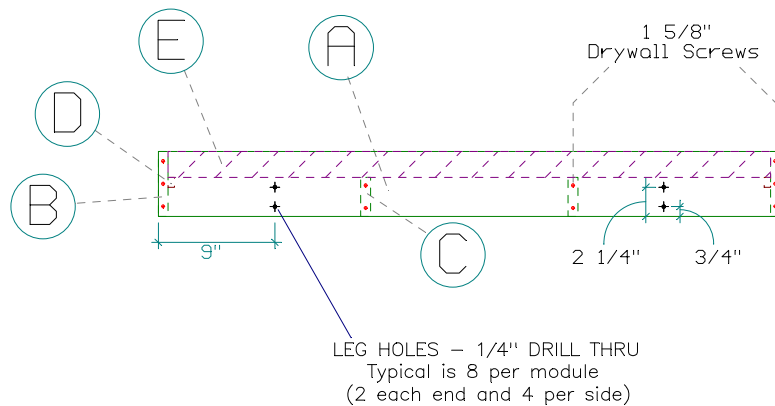

Item	Description	Dimensions	Qty
A	Cabinet Grade Plywood	3/4" x 5" x 48"	2
B	Cabinet Grade Plywood	3/4" x 5" x 22 3/4"	2
C	Cabinet Grade Plywood	3/4" x 3" x 22 3/4"	2
D	Cabinet Grade Plywood	3/4" x 3/4" x 22"	2
E	2" Extruded Foam Isulation	2" x 22 1/2" x 46 1/2"	1

Not to Scale

Cabinet Grade Plywood with Dado Joints

Top View

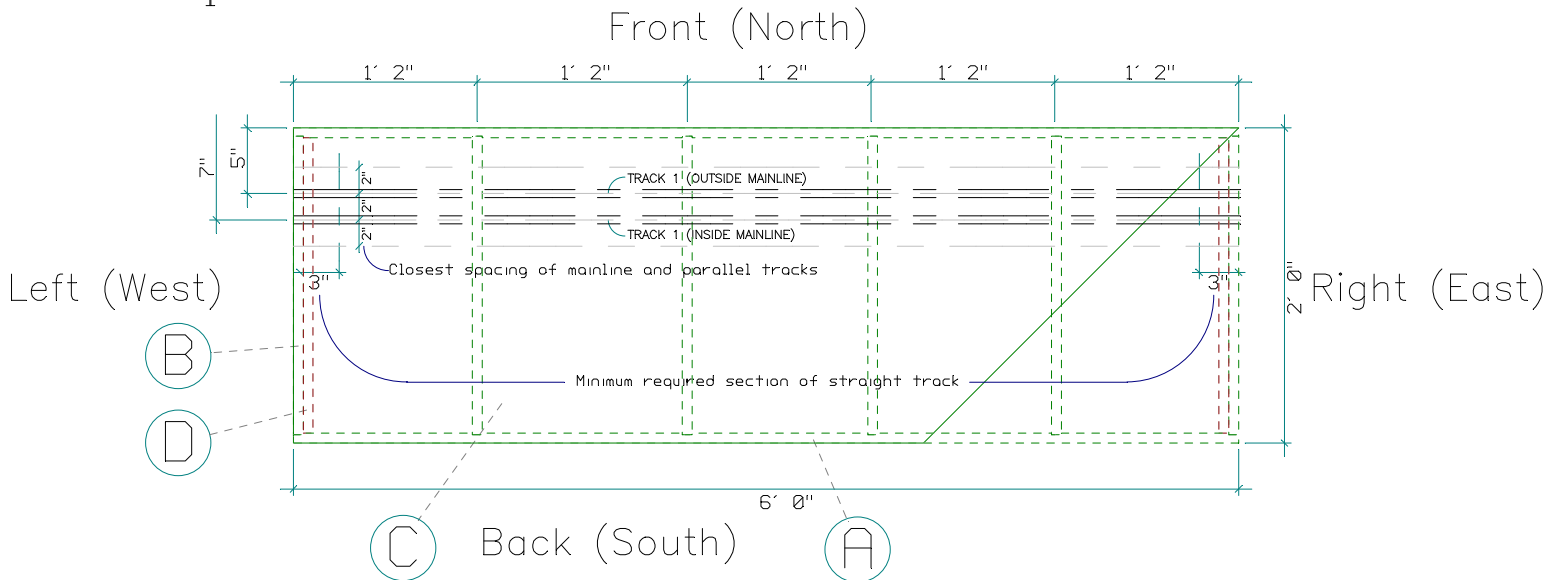

Side View

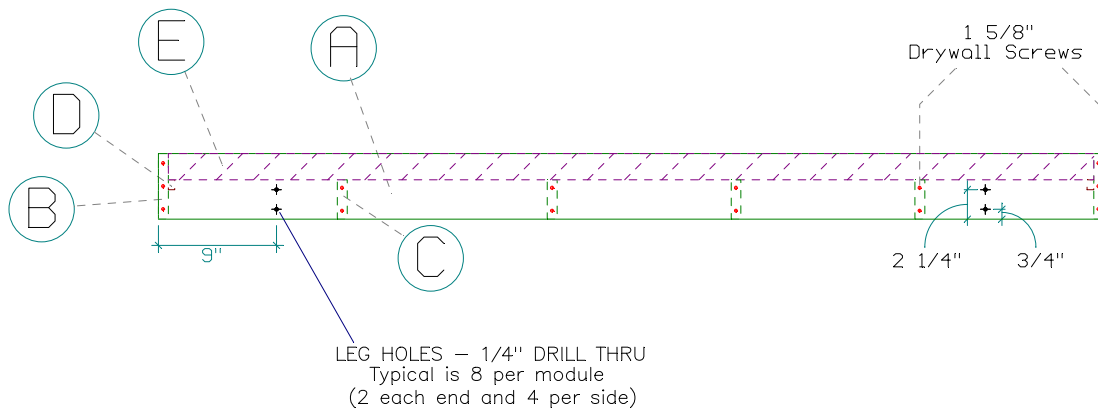

Item	Description	Dimensions	Qty
A	Cabinet Grade Plywood	3/4" x 5" x 72"	2
B	Cabinet Grade Plywood	3/4" x 5" x 22 3/4"	2
C	Cabinet Grade Plywood	3/4" x 3" x 22 3/4"	2
D	Cabinet Grade Plywood	3/4" x 3/4" x 22"	2
E	2" Extruded Foam Isulation	2" x 22 1/2" x 70 1/2"	1

Not to Scale

Top View

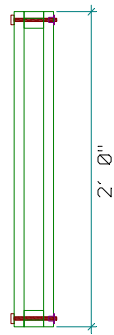

Side View

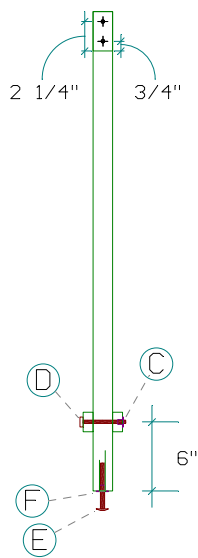

End View

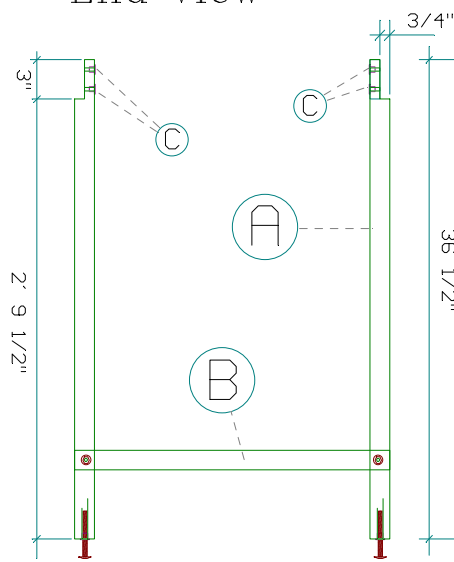

A	2" X Pine (any dim. ripped to 1 1/2")	[1 1/2" x 1 1/2" x 36 1/2"]	2
B	Cabinet Grade Plywood	[3/4" x 1 1/2" x 24"]	2
C	1/4 - 20 T-Nut		6
D	1/4" - 20 Hex Bolt	[3"]	2
E	5/16 - 18 Carraige Bolt	[4"]	2
F	5/16" - 18 T-Nut		1

Not to Scale

Corner Module

Top View

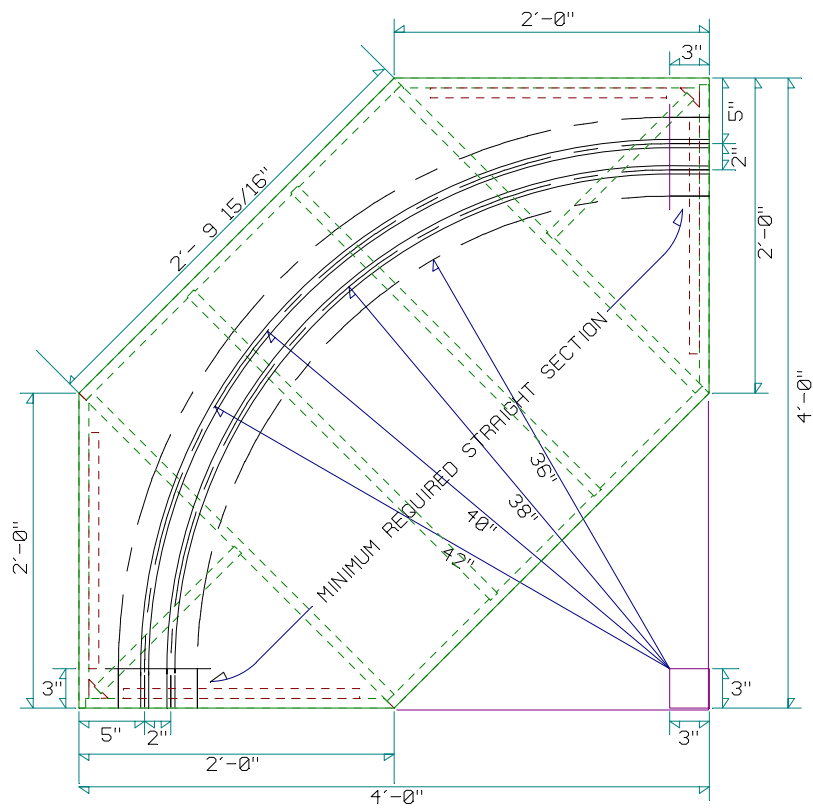

Item	Description	Dimensions	Qty
A			
B			
C			
D			
E			

Not to Scale